

3/S3
v 2.4 (hr)

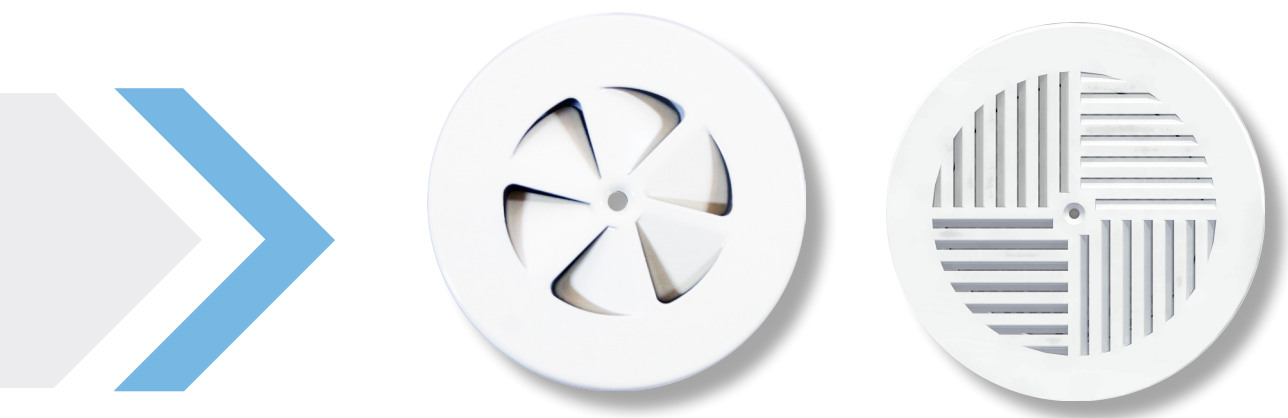

**ISTRUJNA ROZETA
STUBIŠNI DISTRIBUTER VRTLOŽNI
DISTRIBUTER STUBIŠNI KRILASTI**

IR, SDV, DSK

SADRŽAJ

Istrujna rozeta, tip IR.....	211
Stubišni distributer vrtložni, tip SDV.....	212
Distributer stubišni krilasti, tip DSK.....	216

Oznake:

V	[m ³ /h]	- protok zraka kroz rozetu	Δp_t	[Pa]	- pad tlaka
v_k	[m/s]	- brzina u kanalu	Δt_z	[°C]	- brzina u kanalu
V_0	[m/s]	- efektivna istrujna brzina			
v_L	[m/s]	- brzina na dometu			
L	[m]	- domet			
L_{WA}	[dB(A)]	- buka			
$\alpha = 6^\circ$		- kut širenja mlaza			
B	[m]	- širina mlaza			

ISTRUJNA ROZETA - IR

- Namijenjena je za ventilaciju i klimatizaciju u kino dvoranama, kazališnim, koncertnim i sličnim dvoranama.
- Izrađena je iz čeličnog lima i standardno plastificirana u RAL 9010.

Opcije

- RAL...

Ugradnja

- sa traverzom i centralnim vijkom (standardno)

- sa kutijom

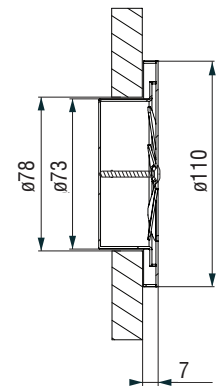
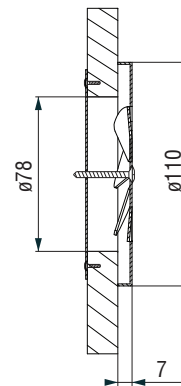
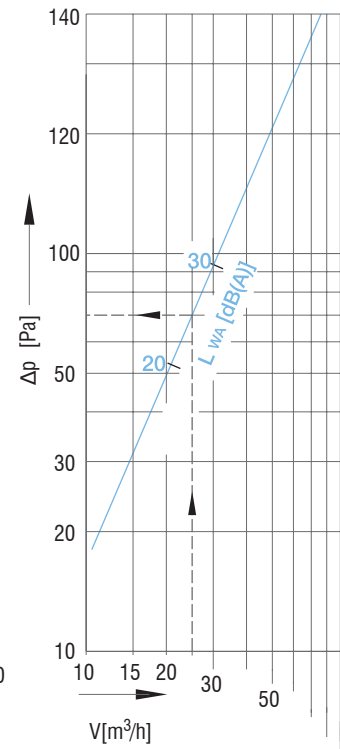
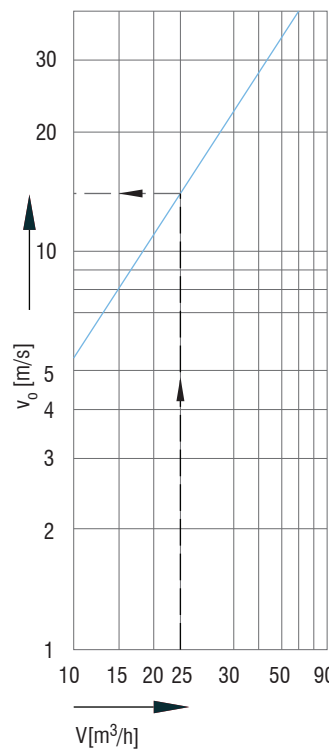
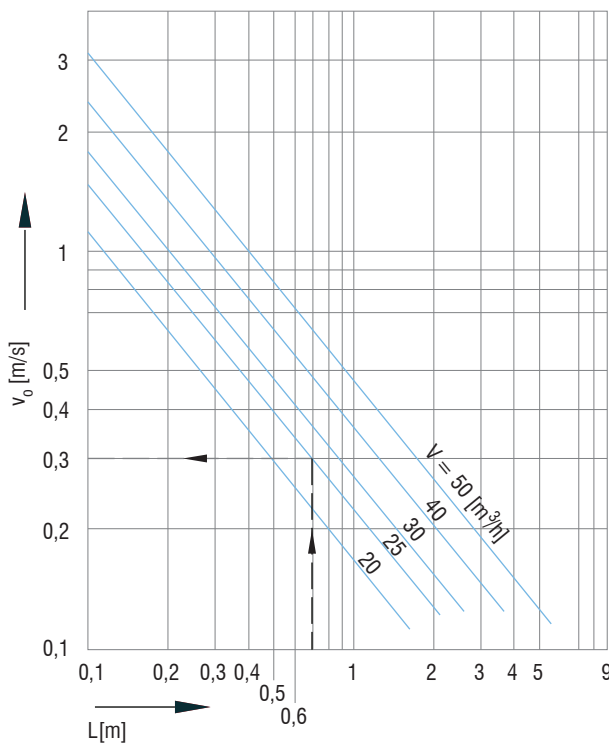
Izborni dijagram

Oznaka za narudžbu

Istrujna rozeta **IR - O - T - RAL...**
O - okrugli
K - kvadratni
 Priključak s: **K** - kutijom
T - traverzom



STUBIŠNI DISTRIBUTER VRTLOŽNI - SDV

- Stubišni distributeri zraka tip SDV namjenjen je za ugradnju u kazališta, koncertne dvorane, kina i slične dvorane.
- Stubišni distributer zraka napravljen je od čeličnog lima, istrujna ploča je standardno plastificirana u RAL 9010.

Opcije

- RAL...

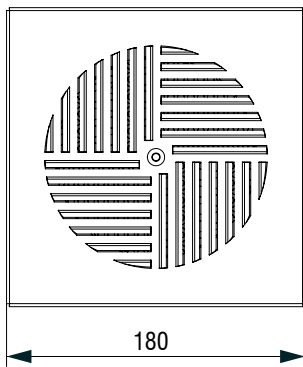
SDV-KO



SDV-KK

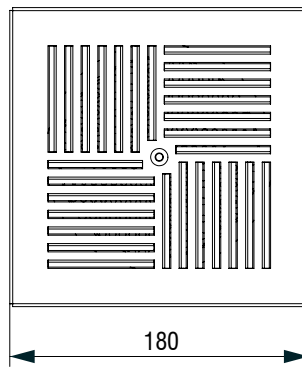

SDV-00

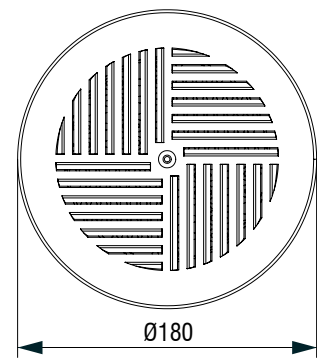
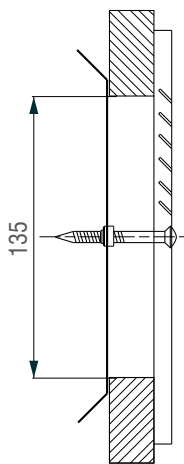
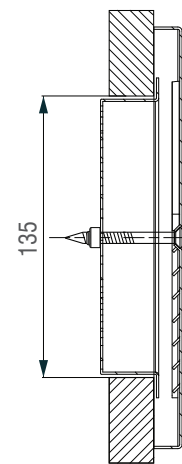
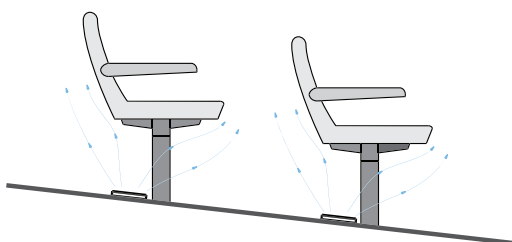
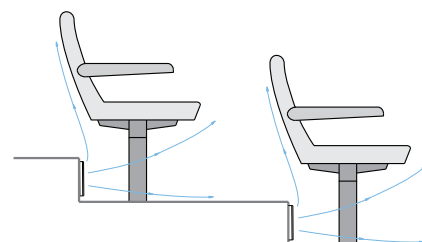
Ugradnja centralnim vijkom i traverzom (standardno)

Ugradnja sa kućištem

Podna ugradnja

Stubna ugradnja

Oznaka za narudžbu

 Stubišni distributer **SDV - OO - K - 180 - RAL...**
KK - kvadratna istrujna ploča

OO -okrugla

KO - kvadratno-kružna

 Priključak s: **K** - kutijom

T - traverzom

Veličina

Izborni dijagrami

Razina zvučne snage i pad tlaka SDV-T

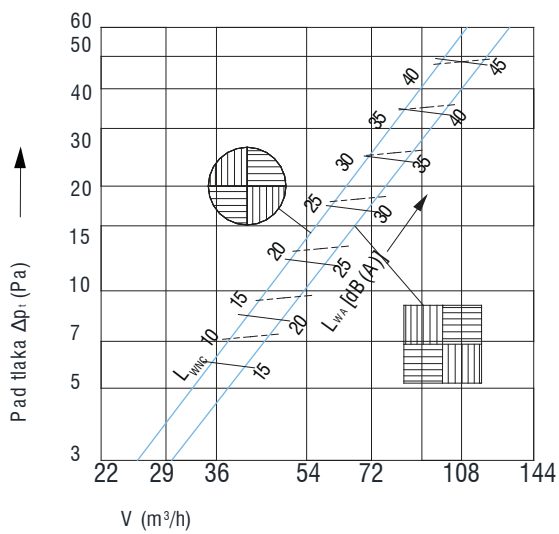

Razina zvučne snage i pad tlaka SDV-K

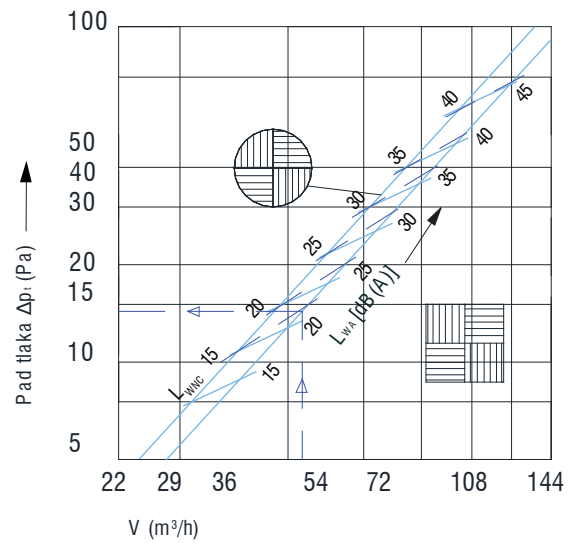

Razina zvučne snage i pad tlaka SDV-KO-T

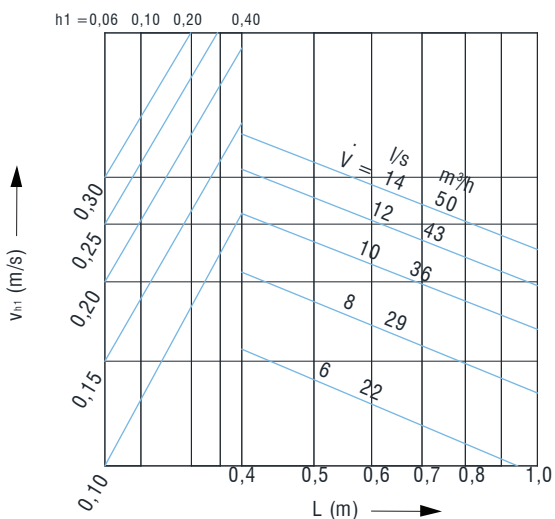

Razina zvučne snage i pad tlaka SDV-KK-T

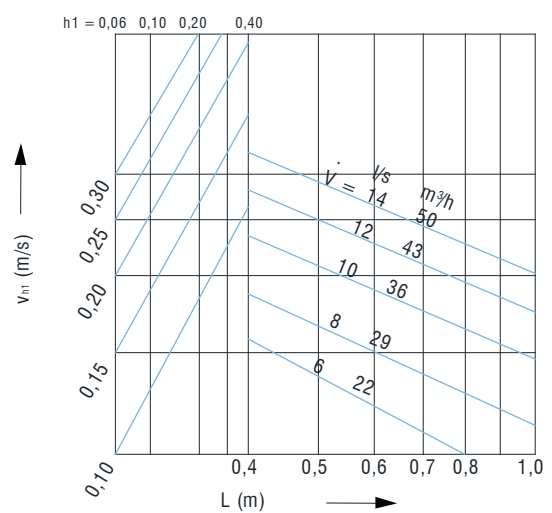

Razina zvučne snage i pad tlaka SDV-KO-T podno

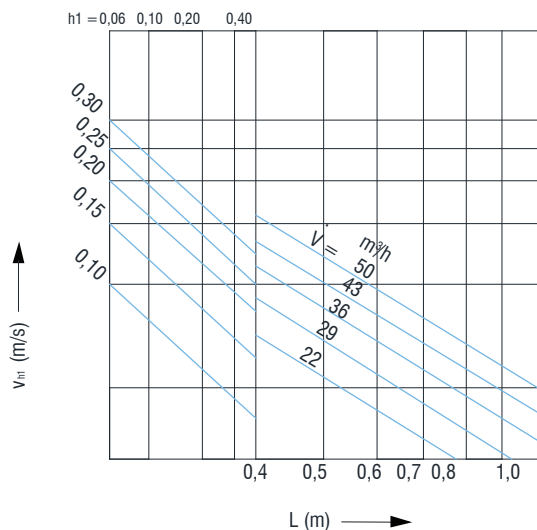

Razina zvučne snage i pad tlaka SDV-KO-K stubno

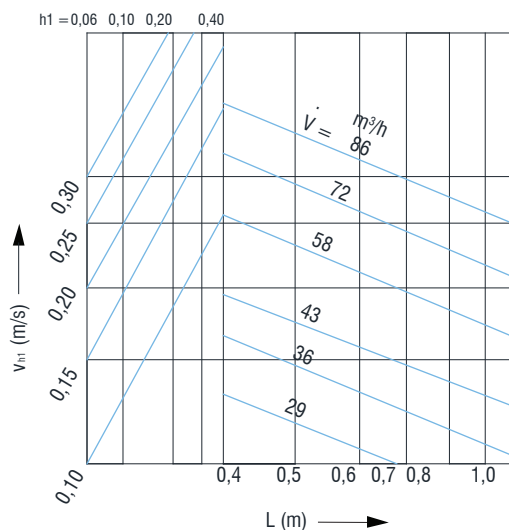

Razina zvučne snage i pad tlaka SDV-KK-T podno

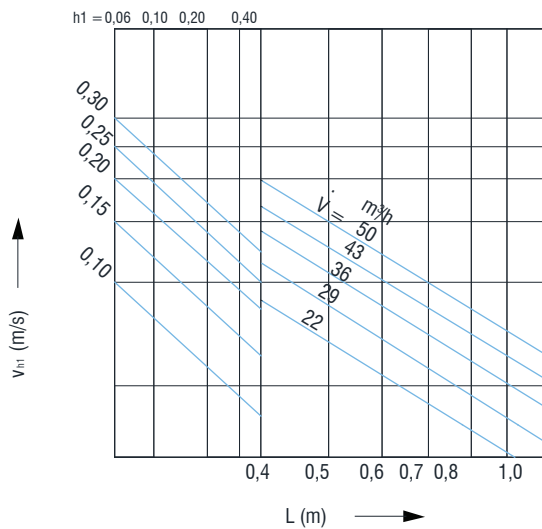

Razina zvučne snage i pad tlaka SDV-KK-K stubno

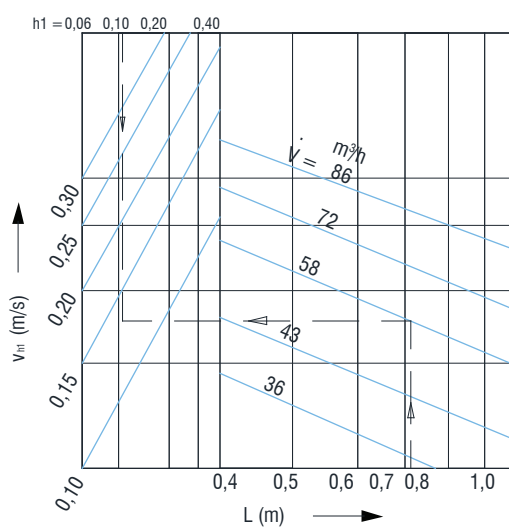

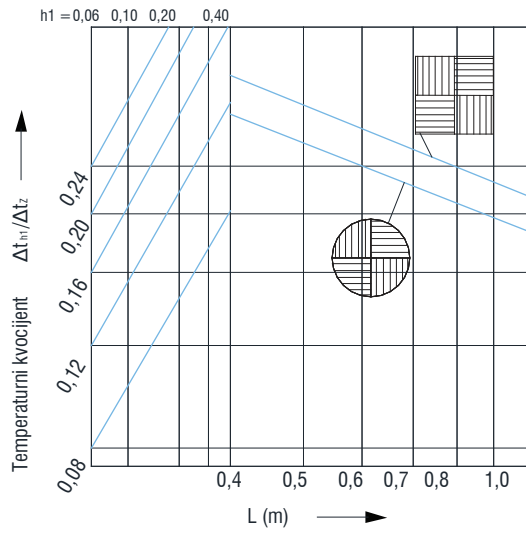
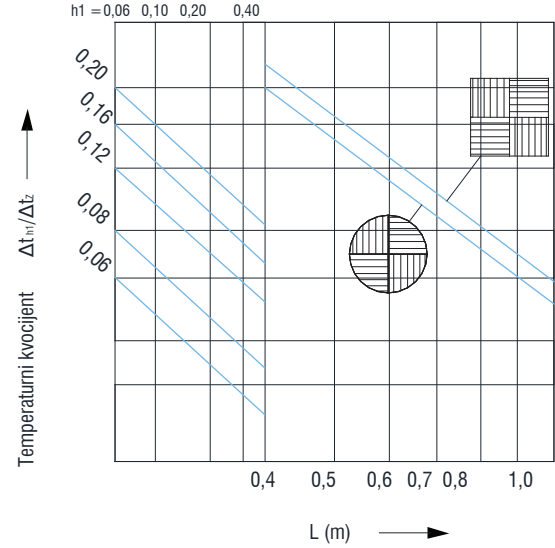
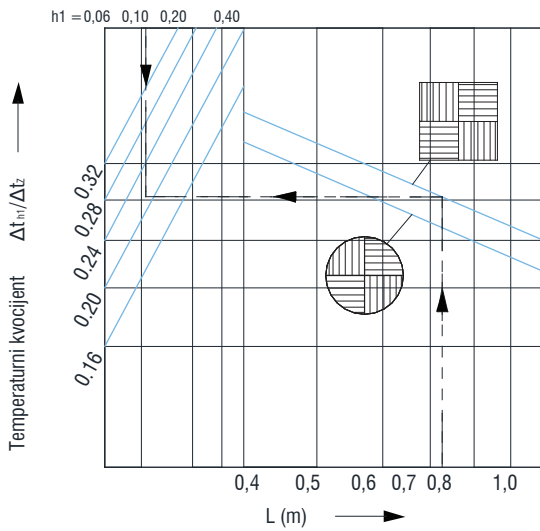
Temperaturni kvocijent SDV-T stubno

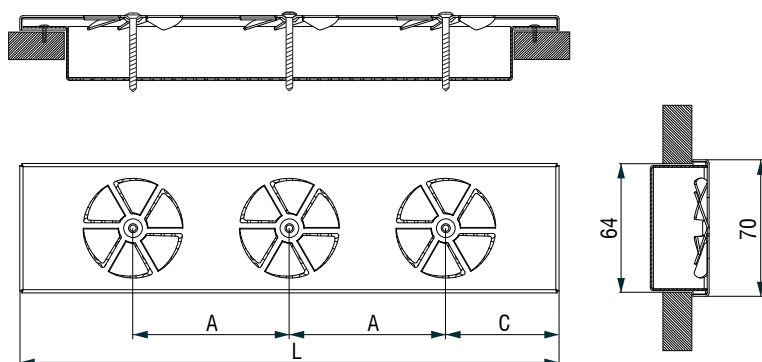
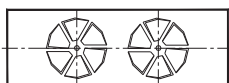
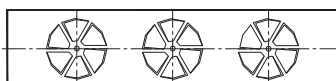
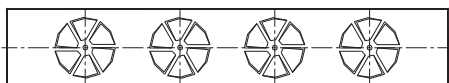
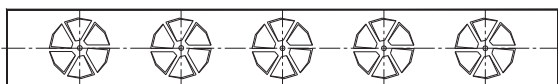
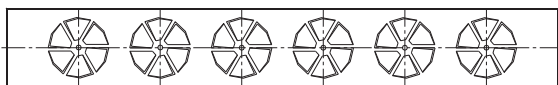
Temperaturni kvocijent SDV-T podno

Temperaturni kvocijent SDV-K stubno



DSK-2

DSK-3

DSK-4

DSK-5

DSK-6

DISTRIBUTER STUBIŠNI KRILASTI - TIP DSK

- namijenjena je za ventilaciju i klimatizaciju u kino dvoranama, kazališnim, koncertnim i sličnim dvoranama.
- vertikalna ugradnja u stube (površina nije nagazna)
- prednja istrujna ploča izrađena od aluminija, kućište od pocinčanog čeličnog lima
- ugradnja vijcima

Dimenzija	L	C	A
DSK 2	200	63	74
DSK 3	300	63	87
DSK 4	400	71	86
DSK 5	500	66	92
DSK 6	500	65	74

Efektivna istrujna površina	
Broj istrujnih elemenata	A_{ef} [10^{-6} m ²]
1	631
2	1262
3	1893
4	2524
5	3155
6	3786

Oznaka za narudžbu:

 Istrujna rozeta **DSK - 2 - PK - RAL...**

Broj otvora

Priključna kutija

Prikaz istrujavanja

